

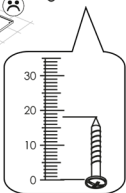



<b>B3</b>  Ø35 2	<b>B5</b>  10x50 2	<b>C1</b>  8x35 2	<b>I</b>  S4 1
<b>K10</b>  5	<b>M4</b>  M4x22 16	<b>R25</b>  7x70 5	<b>R27</b>  5.0x13 4
<b>Y4</b>  344 2(0*)	<b>Y3</b>  1(0*)	<b>Y5</b>  1(0*)	<b>Y6</b>  1(0*)



	mm	mm	mm	
1	1460	800	16	1
2	798	284	16	1
3	748	284	16	1

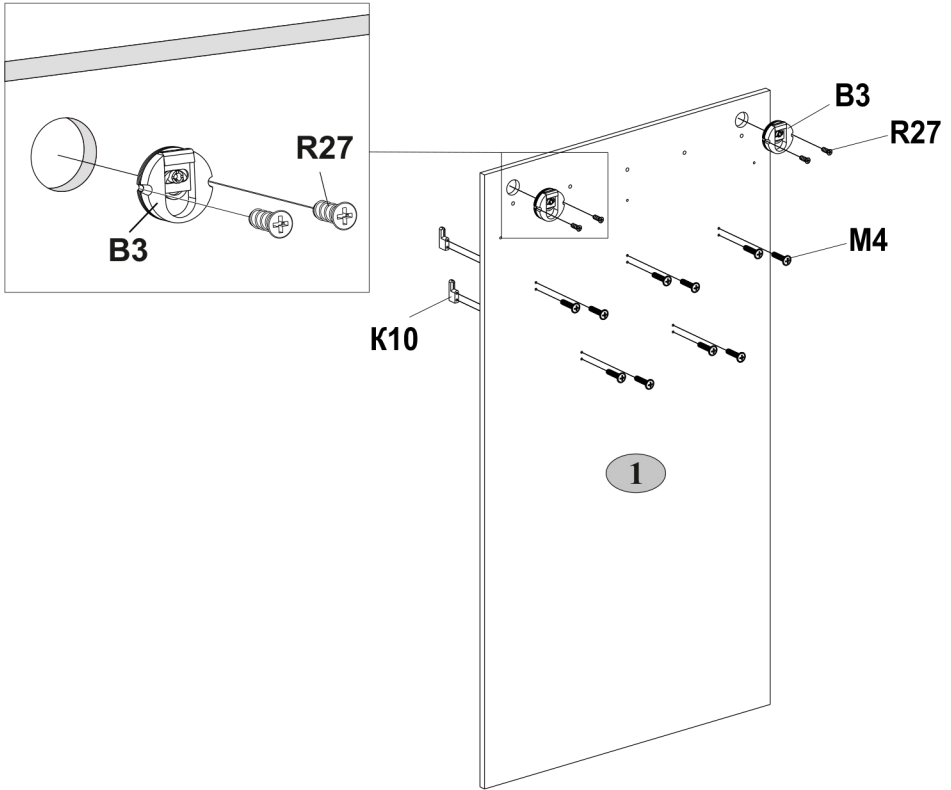

**1**

<b>B3</b>  Ø35	<b>K10</b> 	<b>M4</b>  M4x22	<b>R27</b>  5,0x13
2	5	10	4

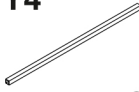
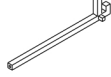
**2**

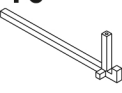
<b>Y4</b>  345	<b>Y3</b> 	<b>Y5</b> 	<b>Y6</b> 
2	1	1	1

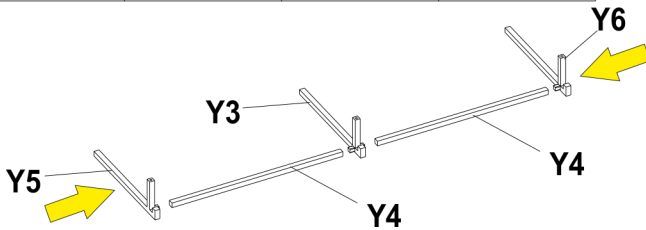

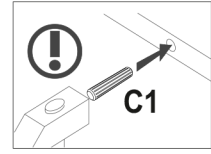
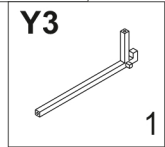
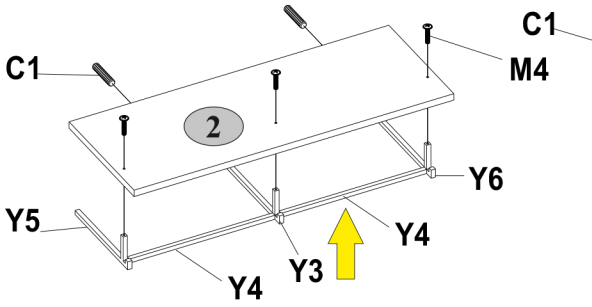
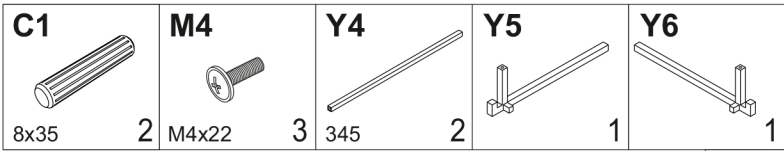
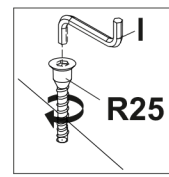
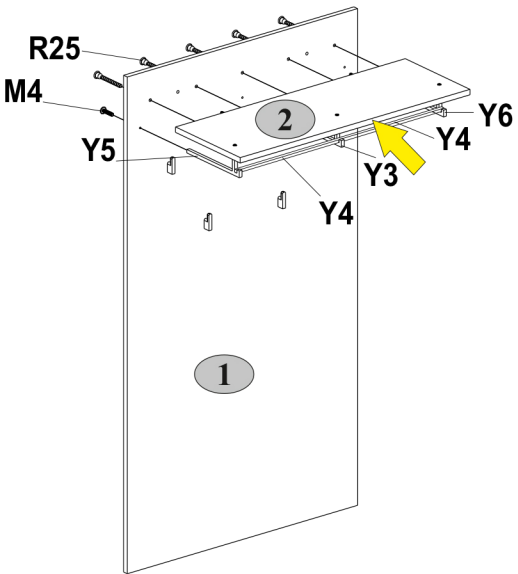
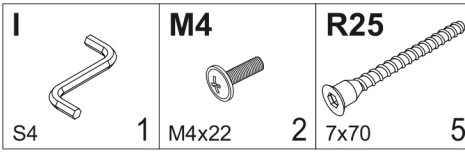
**3****4**

**5**

